

Instruction Manual

HI2300

EC/TDS/NaCl Bench Meter

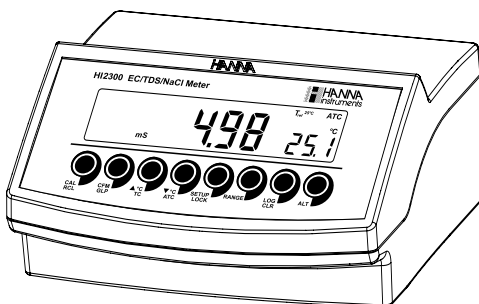

www.hannainst.com

Dear Customer,

Thank you for choosing a Hanna Instruments product.

Please read this instruction manual carefully before using the bench meter.

For more information about Hanna Instruments and our products, visit www.hannainst.com or e-mail us at sales@hannainst.com.

For technical support, contact your local Hanna Instruments Office or e-mail us at tech@hannainst.com.

All rights are reserved. Reproduction in whole or in part is prohibited without the written consent of the copyright owner, Hanna Instruments Inc., Woonsocket, Rhode Island, 02895, USA.

TABLE OF CONTENTS

PRELIMINARY EXAMINATION.....	4
GENERAL DESCRIPTION.....	4
FUNCTIONAL DESCRIPTION.....	5
SPECIFICATIONS.....	6
OPERATIONAL GUIDE.....	7
AUTO-RANGING.....	9
EC/TDS CALIBRATION.....	10
CONDUCTIVITY VERSUS TEMPERATURE CHART.....	12
NaCl CALIBRATION.....	13
GOOD LABORATORY PRACTICE (GLP).....	14
LOGGING FUNCTION.....	16
SETUP.....	21
TEMPERATURE CALIBRATION (for technical personnel only).....	25
PC INTERFACE.....	26
PROBE MAINTENANCE.....	30
TROUBLESHOOTING GUIDE.....	31
ACCESSORIES.....	32

PRELIMINARY EXAMINATION

Remove the instrument from the packing material and examine it carefully to make sure that no damage has occurred during shipping. If there is any damage, please contact your local Hanna Instruments Office.

Each instrument is supplied with:

- **HI76310** Conductivity / TDS probe
- **HI76404N** Electrode Holder
- 12VDC Power Adapter
- Instruction Manual
- Quick Reference Guide
- Quality Certificate

Note: Save all packing material until you are sure that the instrument functions correctly. All defective items must be returned in the original packing with the supplied accessories.

GENERAL DESCRIPTION

The **HI2300** is a logging microprocessor-based Conductivity (EC), TDS, NaCl and Temperature bench meter.

The conductivity measurements are compensated for temperature effect manually or automatically with the temperature sensor inside the conductivity probe. It is also possible to disable the temperature compensation and measure the actual conductivity.

The auto-ranging feature of the EC and TDS ranges automatically sets the instrument to the scale with the highest possible resolution.

The temperature coefficient on EC range is user selectable.

The **GLP** feature provides a guarantee of data consistency.

The instrument can store data in memory for later retrieval. The meter's memory can hold 500 manually logged points.

An USB connection ensures communication with a PC.

FUNCTIONAL DESCRIPTION

Front Panel

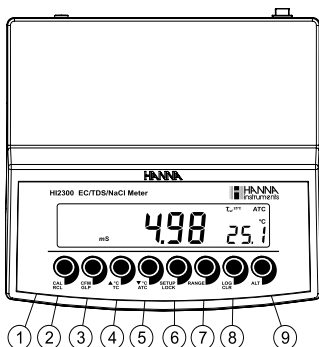

Rear Panel

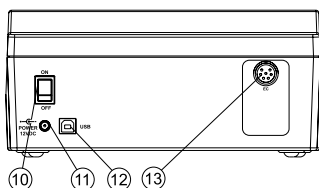

- 1) Liquid Crystal Display (LCD).
- 2) **CAL** key, to enter and exit calibration mode.
RCL key (alternate function), to enter and exit memory recall.
- 3) **CFM/GLP** key, to confirm calibration selection, different setup values or to display Good Laboratory Practice information.
- 4) **▲°C** key, to manually increase temperature value or other parameters.
TC key (alternate function), to view temperature coefficient value.
- 5) **▼°C** key, to manually decrease temperature value or other parameters.
ATC key (alternate function), to select EC temperature compensation mode.
- 6) **SETUP** key, to enter/exit SETUP mode.
LOCK key (alternate function), to freeze current EC range on the LCD.
- 7) **RANGE** key, to select measurement range (EC, TDS, NaCl), switch to focused data in SETUP or toggle between standard value and temperature during calibration.
- 8) **LOG/CLR** key, to store a value into memory, or to select to delete log records.
- 9) **ALT** key, to select alternate function.
- 10) **ON/OFF** switch.
- 11) Power supply socket.
- 12) USB connector.
- 13) EC probe connector.

SPECIFICATIONS

EC Calibration	1 point slope calibration; 6 buffers available: 84.0, 1413 $\mu\text{S}/\text{cm}$ 5.00, 12.88, 80.0, 111.8 mS/cm 1 point offset: 0.00 mS/cm
NaCl Calibration	1 point with HI7037L buffer (optional)
Temperature compensation	Manual or Automatic from: –20.0 to 120.0 °C (can be disabled to measure actual conductivity)
Conductivity temperature coefficient	0.00 to 6.00% / °C (for EC and TDS only) default value is 1.90% / °C
TDS factor	0.40 to 0.80 (default value is 0.50)
EC Probe	HI76310
Log on demand feature	500 records
PC communication	Optoisolated USB
Power supply	12 VDC adapter
Dimensions	235 x 222 x 109 mm (9.2 x 8.7 x 4.3")
Weight	1.3 Kg (2.9 lb); kit with holder 2.1 Kg (4.6 lb)
Environment	0 – 50 °C (32 – 122 °F) max. 95% RH non-condensing
Warranty	2 years

(*) Actual conductivity (or TDS) is the conductivity (or TDS) value without temperature compensation.

OPERATIONAL GUIDE

POWER CONNECTION

Plug the 12 VDC adapter into the power supply socket.

- Notes:**
- This instrument uses non volatile memory to retain the calibration parameters and all other settings, even when unplugged.
 - Make sure a fuse protects the main line.

PROBE CONNECTION

For EC/TDS or temperature measurements connect the probe to the 7-pin connector. Make sure the probe sleeve is properly inserted.

INSTRUMENT START-UP

- Turn the instrument on by pressing the **ON/OFF** switch located on the rear panel.
- All LCD tags are displayed and a beep is sounded while the instruments perform a self test.



- The instrument will display “LoAd” message and “8” blinking until initialization is complete.

- Notes:**
- The instrument starts in the same range and mode as it was at power off.
 - The **RANGE** key toggles between measurement ranges:
 - EC, TDS and NaCl.

CONDUCTIVITY MEASUREMENTS

Connect the conductivity probe to the instrument.

- Press the **RANGE** key to enter conductivity measurement range (EC).
- Submerge the probe into the solution to be tested. The sleeve holes must be completely submersed. Tap the probe repeatedly to remove any air bubbles that may be trapped inside the sleeve.
- The conductivity value will be displayed on the primary LCD and the temperature on the secondary LCD.
- If the reading is out of range, the full-scale value (200.0 for Mtc/Atc mode or 500.0 for actual conductivity) will be displayed blinking.



The conductivity reading is affected by temperature.

Three options for temperature compensation are available in conductivity measurement mode.

Note: The compensation is referenced at the selected reference temperature (see SETUP for details, page 21).

To select the desired option, press the **ALT&ATC** keys until the option is displayed on the LCD.



Automatic (Atc): The conductivity probe has a built-in temperature sensor; the temperature value is used to automatically compensate the EC/TDS reading.

Manual (Mtc): The temperature value, shown on the secondary LCD, can be manually set with the **ARROW** keys. The “°C” tag blinks when this option is active. This value will be used to compensate the EC/TDS reading.

No Compensation (notc): The temperature value is displayed, but not taken into account. When this option is selected the “°C” tag will blink with slower frequency. The reading displayed on the primary LCD is the uncompensated EC or TDS value.

Notes: • The default compensation mode is **Atc**.

- If no temperature probe is detected, **Atc** mode can not be selected and the instrument displays “----” on the secondary LCD.

If temperature compensation is selected, measurements are compensated using the temperature coefficient (default value 1.90 %/°C). To change the temperature coefficient, enter the setup mode and select “tc” (see SETUP for details, page 21). The current temperature coefficient can be quickly viewed by pressing the **ALT&TC** keys in **Atc** and **Mtc** modes. The value is briefly displayed on the secondary LCD.

- If the temperature reading exceeds the limits of the meter (–20.0 °C to 120.0 °C), the “°C” tag will blink and the closest full-scale value will be displayed.

TDS MEASUREMENTS

Press the **RANGE** keys while in EC range. The instrument will switch to TDS measuring range. The TDS reading will be displayed on the primary LCD and the temperature reading on the secondary LCD.

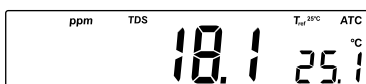

- If the reading is out of range, the full-scale value (100.0 for Mtc/Atc mode or 400.0 for uncompensated TDS) will be displayed blinking.
- If **LOCK** was pressed to freeze the LCD range and the reading goes out of range, the full-scale value of the frozen range will be displayed blinking.

NaCl MEASUREMENTS



Press the **RANGE** keys while in EC range until NaCl is displayed on the LCD. The instrument will display the NaCl reading on the primary LCD and the temperature reading on the secondary LCD line.



- If the reading is out of range, the full-scale value (400.0%) will be displayed blinking.

AUTO-RANGING

The EC and TDS scales are auto-ranging. The meter automatically sets the scale with the highest possible resolution.

By pressing **ALT&LOCK**, the auto-ranging feature is disabled and the current range is frozen on the LCD. The "LOCK" tag will be displayed on the LCD.

Note: Auto-ranging is automatically restored if the range is changed, if the setup or calibration modes are entered and if the meter is turned off and back on again.

When auto-ranging is disabled and the reading goes out of range, the full-scale value of the frozen range will be displayed blinking.

EC/TDS CALIBRATION

Selectable calibration points for conductivity are 0.00 μS for offset and 84.0 μS , 1413 μS , 5.00 mS, 12.88 mS, 80.0 mS, 111.8 mS for slope.

Rinse the probe with calibration solution or deionized water. Submerge the probe into the solution. The sleeve holes must be completely submerged. Tap the probe repeatedly to remove any air bubbles that may be trapped inside the sleeve.



To enter EC calibration, select the EC range and press **CAL**.

The “**BUF**” and “**CAL**” tags are displayed. The primary LCD will display the EC reading. The secondary LCD will display the standard value. The “**Σ**” and “**~**” tags will blink and the information about temperature compensation is displayed.



Note: The TDS reading is automatically derived from the EC reading and no specific calibration for TDS is needed. Pressing CAL when TDS range is selected has no effect.

For zero calibration, just leave the dry probe in the air. This calibration is performed in order to correct the reading at 0.00 μS . The slope is evaluated when the calibration is performed at any other point.



Select the desired value with the **ARROW** keys, if necessary.



When the reading is stable, “**CFM**” tag starts blinking on the LCD, asking for confirmation.



Press **CFM** to confirm calibration.

The instrument stores the calibration value and returns to measurement mode.



- Notes: • If the reading is too far from the expected value, the “WRONG” and “☀” tags will blink. Calibration can not be confirmed.

In this case check if the calibration solution has been used correctly or clean the probe by following the Probe Maintenance (see page 30).

- If the meter is in **Atc** or **Mtc** mode and the temperature is out of the 0.0 to 60.0 °C interval, “WRONG”, “°C” tags and the temperature will blink.



- For best results choose an EC standard value close to the sample to be measured.
- In order to minimize any EMC interference, use plastic or glass beakers.
- It is possible to set the cell constant value directly, without following the calibration procedure. To set the cell constant, enter SETUP mode and select “CELL” (see SETUP for details, page 21).

CONDUCTIVITY VERSUS TEMPERATURE CHART

The conductivity of an aqueous solution is a measure of its ability to carry an electrical current by means of ionic motion.

The conductivity invariably increases with increasing temperature.

It is affected by the type and number of ions in the solutions and by the viscosity of the solution itself. Both parameters are temperature dependent. The dependency of conductivity on temperature is expressed as a relative change per Celsius degrees at a particular temperature, commonly as %/°C.

The following table lists the temperature dependence of HANNA EC calibration standards.

°C	°F	HI7030 HI8030 (µS/cm)	HI7031 HI8031 (µS/cm)	HI7033 HI8033 (µS/cm)	HI7034 HI8034 (µS/cm)	HI7035 HI8035 (µS/cm)	HI7039 HI8039 (µS/cm)
0	32	7150	776	64	48300	65400	2760
5	41	8220	896	65	53500	74100	3180
10	50	9330	1020	67	59600	83200	3615
15	59	10480	1147	68	65400	92500	4063
16	60.8	10720	1173	70	67200	94400	4155
17	62.6	10950	1199	71	68500	96300	4245
18	64.4	11190	1225	73	69800	98200	4337
19	66.2	11430	1251	74	71300	100200	4429
20	68	11670	1278	76	72400	102100	4523
21	69.8	11910	1305	78	74000	104000	4617
22	71.6	12150	1332	79	75200	105900	4711
23	73.4	12390	1359	81	76500	107900	4805
24	75.2	12640	1386	82	78300	109800	4902
25	77	12880	1413	84	80000	111800	5000
26	78.8	13130	1440	86	81300	113800	5096
27	80.6	13370	1467	87	83000	115700	5190
28	82.4	13620	1494	89	84900	117700	5286
29	84.2	13870	1521	90	86300	119700	5383
30	86	14120	1548	92	88200	121800	5479
31	87.8	14370	1575	94	90000	123900	5575

NaCl CALIBRATION

NaCl calibration is a one-point calibration at 100.0% NaCl. Use the **HI7037L** calibration solution (sea water solution) as a 100% NaCl calibration solution.

Rinse the probe with some of the calibration solution or deionized water. Submerge the probe into **HI7037L** solution. The sleeve holes must be completely submersed. Tap the probe repeatedly to remove any air bubbles that may be trapped inside the sleeve.



To enter NaCl calibration select the NaCl range and press **CAL**.



The “**BUF**” and “**CAL**” tags are displayed. The primary LCD will display the NaCl reading in percentage. The secondary LCD will display “**100**”. The “**Σ**” and “**~**” tags will blink.



When the reading is stable, the “**CFM**” tag starts blinking on the LCD, asking for confirmation.



Press **CFM** to confirm calibration.

The instrument stores the calibration value and returns to measurement mode.



- Notes:**
- If the reading is too far from the expected value, “**WRONG**” “**Σ**” tags will blink. Calibration cannot be confirmed.
 - If the temperature of the standard is out of the 0.0 °C to 60.0 °C temperature interval, the “**WRONG**” and “**°C**” tags and the temperature will blink.
 - If a new EC calibration is performed, the NaCl calibration is automatically cleared. A new NaCl calibration is required.

GOOD LABORATORY PRACTICE (GLP)

GLP is a set of functions that allows storage and retrieval of data regarding the maintenance and status of the system.

All data regarding EC and NaCl calibration is stored for the user to review when necessary.

EC CALIBRATION DATA

EC calibration data is stored automatically after a successful calibration.

To view the EC calibration data, press **GLP** when the instrument is in EC measurement mode.

The instrument will display the time (hh:mm) of the last calibration.



Use the **ARROW** key to scroll through the calibration data.

- The date (mm.dd.yyyy).

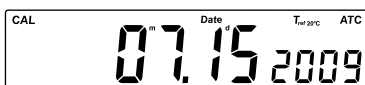

- The calibration offset factor.



- The cell constant.

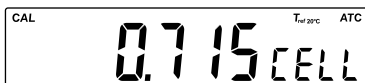

- The EC calibration standard.



- The temperature coefficient.

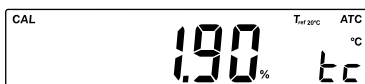

- The instrument ID.



NaCl CALIBRATION DATA

NaCl calibration data is stored automatically after a successful calibration. To view the NaCl calibration data, press **GLP** when the instrument is in NaCl measurement mode.

The instrument will display the time (hh:mm) of the last calibration.



Use the **ARROW** key to scroll through the calibration data.

- The date (mm.dd.yyyy).

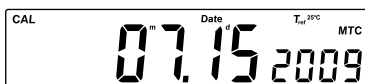

- The salinity coefficient.



- The cell constant.

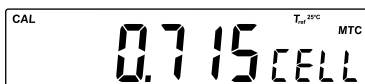

- The instrument ID.



- Notes:**
- If no temperature compensation is selected during calibration, the temperature coefficient is not displayed in GLP.
 - Press **GLP** at any moment and the instrument will return to measurement mode.
 - If calibration has not been performed on the selected range, the instrument displays “no CAL” message blinking.



LOGGING FUNCTION

Up to 500 logged samples can be stored into memory.

LOGGING THE CURRENT DATA

To store the current reading into memory press **LOG** while the instrument is in measurement mode.

The instrument will display the current date (mm.dd) on the primary LCD, the record number on the secondary LCD and “LOG” tag for a few seconds (see example below: record No. 11):



followed by the number of free records:



If there are less than 6 memory locations remaining, the record number and “Lo” message will be displayed to alert the user.

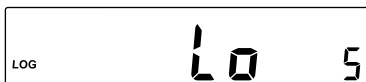

If the log space is full (500 records), "FULL LOG" message will be displayed and no more data will be saved.



When **LOG** is pressed, a complete set of information is stored: date, time, EC, TDS, NaCl, temperature and calibration data.

VIEW LOGGED DATA

Press the **ALT&RCL** keys while in measurement mode to retrieve the stored information.

If no data was logged for the current selected measurement range, one of the next messages will be displayed:

No EC records:

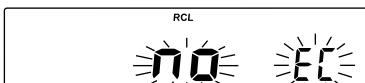
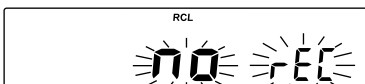

No TDS records:

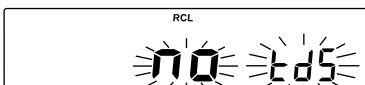

No NaCl records:

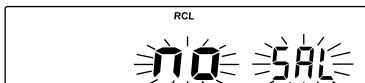

Otherwise, the instrument will display the memorized data, in according with the selected range.

- If **RCL** was entered while in EC measurement range:



In TDS measurement range:



In NaCl measurement range:

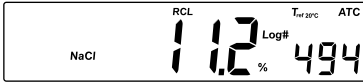

Use the **ARROW** keys, to scroll through the records.

Note: The instrument will automatically skip log records from other measurement ranges.

For EC Range

- The **conductivity** value on the primary LCD and the temperature value on the secondary LCD.

To view additional information press **RANGE**.



- The **time** on the primary LCD, along with "TIME" tag and record number on the secondary LCD.



- The **date** on the primary LCD, along with "DATE" tag.

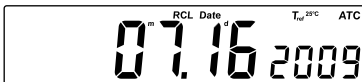

- The **offset factor** on the primary LCD and "OFFS" message on the secondary LCD.



- The **cell constant** on the primary LCD and “CELL” message on the secondary LCD.



- The **temperature coefficient** on the primary LCD and “tc” message on the secondary LCD.

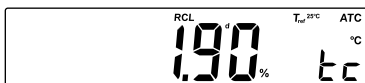

For TDS Range

- The **conductivity** value on the primary LCD and the temperature value on the secondary LCD.



- The time and the date as described in EC Range.
- The **TDS factor** on the primary LCD and the log number on the secondary LCD.



- The **temperature coefficient** and the **cell constant** as described in EC Range.

For NaCl Range

- The conductivity and temperature reading value as described in TDS Range.
- The time and date as described in EC Range.
- The **salinity factor** on the primary LCD and the log number on the secondary LCD, with “RCL” and “NaCl” tags displayed.



- The reference temperature, the temperature compensation mode and the cell constant message as described above.

Note: When an information that does not display the record number is selected, pressing the SETUP key will display the record number on the secondary LCD line.

To delete logged records press the CLR key, while viewing the logged data. The “dEL” message is displayed on the primary LCD and the selected record on the secondary LCD, along with “RCL” tag.



- The **ARROW** keys can be used to change the record number.
- Press **SETUP** to select delete all records feature. The display will show “dEL” in the primary LCD and “ALL” in the secondary LCD.



- Press **CFM** to confirm delete. While deleting the “Σ” tag will blink.
- Press **CAL** or **RANGE** or **CLR** to escape and return to the RCL screen.
- If “dEL ALL” option was selected, all the log on demand records are deleted. While deleting the “Σ” tag is displayed blinking.
- Press **ALT&RCL** to return to measurement mode at any time.
- If one or more records were deleted the “Σ” tag blinks until the log memory space is reorganized.

SETUP

Setup mode allows viewing and modifying the following instrument parameters.

The parameters are:

- Cell Constant
- TDS Factor
- Temperature Compensation Coefficient
- Reference Temperature
- Current Time (hour & minute)
- Current Date (year, month & day)
- Beep Status
- Instrument Id
- Temperature Unit

To enter **SETUP** mode press **SETUP** while the instrument is in measurement mode.

Select a parameter with the **ARROW** keys.

Press **CAL** to change a parameter value. The selected parameter will start blinking.

Press **RANGE** to toggle between displayed parameters.

Press the **ARROW** keys to increase or decrease the displayed value.

Press **CFM** to save the modified value or **CAL** to escape without saving.

CELL CONSTANT

Press **CAL** when the cell constant is displayed. The cell constant value and “**CFM**” tag will start blinking.



Press the **ARROW** keys to change the cell constant (0.500 to 1.700).

Press **CFM** to save the modified cell constant.

Press **CAL** to escape without saving.

TDS FACTOR

Press **CAL** when “TDS fact.” is displayed. The TDS factor and “CFM” tag will start blinking.

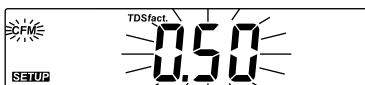

Press the **ARROW** keys to change the TDS factor (0.40 to 0.80).

Press **CFM** to save the modified TDS factor.

Press **CAL** to escape without saving.

TEMPERATURE COMPENSATION COEFFICIENT

Press **CAL** when the temperature compensation coefficient is displayed. The temperature compensation coefficient and “CFM” tag will start blinking.



Press the **ARROW** keys to change the temperature compensation coefficient. (0.00 to 6.00 %/°C).

Press **CFM** to save the modified temperature compensation coefficient.

Press **CAL** to escape without saving.

REFERENCE TEMPERATURE

Press **CAL** when the reference temperature is displayed. The reference temperature value and “CFM” tag will start blinking.



Press the **ARROW** keys to toggle between 20.0 °C and 25.0 °C reference temperature value.

Press **CFM** to save the modified reference temperature value.

Press **CAL** to escape without saving.

CURRENT TIME

Press **CAL** when the current time is displayed. The hour and “CFM” tag will start blinking.



Press the **ARROW** keys to change the hour.

Press **RANGE**. The minutes and “CFM” tag will start blinking.



Press the **ARROW** keys to change the minutes.

Press **CFM** to save the modified value.

Press **CAL** to escape without saving.

CURRENT DATE

Press **CAL** when the current date is displayed. The month and “CFM” tag will start blinking.



Press the **ARROW** keys to change the month.

Press **RANGE**. The day and “CFM” tag will start blinking.



Press the **ARROW** keys to change the day.

Press **RANGE**. The year and “CFM” tag will start blinking.



Press the **ARROW** keys to change the year.

Press **CFM** to save the modified value.

Press **CAL** to escape without saving.

BEEP STATUS

Press **CAL** when the beep status is displayed. Beep status (“On” or “OFF”) and “CFM” tag will start blinking.



Press the **ARROW** keys to change the beep status (On or OFF).

Press **CFM** to save the modified beep status.

Press **CAL** to escape without saving.

When enabled, beep sounds as a short beep every time a key is pressed or when the calibration can be confirmed.

A long beep alert means that the pressed key is not active or a wrong condition is detected while in calibration.

INSTRUMENT ID

Press **CAL** when “InId” is displayed. The instrument ID (“0000” to “9999”) and “CFM” tag will start blinking.



Press the **ARROW** keys to change the instrument ID value.

Press **CFM** to save the modified instrument ID value.

Press **CAL** to escape without saving.

Note: The instrument ID is downloaded to a PC as part of a logged data, set to identify its origin.

TEMPERATURE UNIT

Press **CAL** when “Unit” is displayed. The temperature unit and “CFM” tag will start blinking.

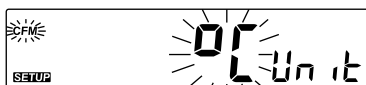

Press the **ARROW** keys to change the option.

Press **CFM** to save the modified temperature unit.

Press **CAL** to escape without saving.

TEMPERATURE CALIBRATION (for technical personnel only)

All the instruments are factory calibrated for temperature.

Hanna Instruments' temperature probes are interchangeable and no temperature calibration is needed when they are replaced.

If the temperature measurements are inaccurate, temperature recalibration should be performed.

For an accurate recalibration, contact your local Hanna Instruments Office or follow the instructions below.

- Prepare a vessel containing ice and water and another one containing hot water (around 50 °C). Place insulation material around the vessels to minimize temperature changes.
- Use a calibrated thermometer with a resolution of 0.1 °C as a reference thermometer. Connect the EC probe to the appropriate socket.
- With the instrument off, press and hold down **CFM&SETUP** keys and then power on the instrument. The "CAL" tag will appear and the secondary LCD will show "0.0 °C".



- Submerge the EC probe in the vessel with ice and water as near as possible to the calibrated thermometer. Allow a few seconds for the probe to stabilize.
- Use the **ARROW** keys to set the reading on the secondary LCD to that of ice and water, measured by the calibrated thermometer. When the reading is stable and close to the selected calibration point, the "CFM" tag will blink.
- Press **CFM** to confirm. The secondary LCD will show "50.0 °C".

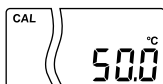

- Submerge the EC probe in the second vessel as near as possible to the calibrated thermometer. Allow a few seconds for the probe to stabilize.

- Use the **ARROW** keys to set the reading on the secondary LCD to that of the hot water.



- When the reading is stable and close to the selected calibration point, the “CFM” tag will blink.
- Press **CFM** to confirm. The instrument memorize calibration and restart in measurement mode.



Note: If the reading is not close to the selected calibration point, “WRONG” tag will blink. Change the EC probe and restart calibration.

PC INTERFACE

Data transmission from the instrument to the PC can be done with the **HI92000** Windows® compatible software (optional). **HI92000** also offers graphing and an on-line help feature. Data can be exported to the most popular spreadsheet programs for further analysis.

To allow our users access to the latest version of Hanna Instruments PC compatible software, we made the products available for download at <http://software.hannainst.com>. Select the product code and click **Download Now**. After download is complete, use the **setup.exe** file to install the software.

To connect your instrument to a PC, use a standard USB cable connector. Make sure that your instrument is switched off and plug one connector to the instrument USB socket and the other to the USB port of your PC.

Note: If you are not using Hanna Instruments HI92000 software, please see the following instructions.

SENDING COMMANDS FROM PC

It is also possible to remotely control the instrument with any terminal program. Use a standard USB cable to connect the instrument to a PC, start the terminal program and set the communication options as follows: 8, N, 1, no flow control, 9600 baud rate.

COMMAND TYPES

To send a command to the instrument the scheme is:

<command prefix> <command> <CR>

where: <command prefix> is a 16 ASCII character

<command> is the command code (3 characters).

Note: Either small or capital letters can be used.

SIMPLE COMMANDS

RNG	Is equivalent to pressing RANGE
CAL	Is equivalent to pressing CAL
CFM	Is equivalent to pressing CFM
UPC	Is equivalent to pressing the UP arrow key
DWC	Is equivalent to pressing the DOWN arrow key
SET	Is equivalent to pressing SETUP
LOG	Is equivalent to pressing LOG
RCL	Is equivalent to pressing RCL
CHRxx	Change the instrument range according with the parameter value (xx): <ul style="list-style-type: none">• xx=06 EC range• xx=07 TDS range• xx=08 NaCl range

The instrument sends the "ACK" (6) character every time a command is recognized and a "NAK" (21) character for invalid commands.

COMMANDS REQUIRING AN ANSWER

RAS	Causes the instrument to send a complete set of readings in according with the current range: <ul style="list-style-type: none">• Conductivity and temperature reading on EC range.• TDS and temperature reading on TDS range.• NaCl and temperature reading on NaCl range.
------------	---

The answer string contains:

- Meter mode (2 chars):
 - 06- EC range
 - 07- TDS range
 - 08- NaCl range
- Meter status (2 chars of status byte): represents a 8 bit hexadecimal encoding.
 - 0x40 - TDS unit (0 = ppm, 1 = g/L)
 - 0x20 - EC unit (0 = μ S, 1 = mS)
 - 0x10 - temperature probe is connected
 - 0x01 - new GLP data available
 - 0x02 - new SETUP parameter
- Reading status (1 char): R - in range, O - over range, U - under range.

- The reading (corresponding to the selected range) - 7 ASCII chars, including sign and decimal point.
- Temperature reading - 7 ASCII chars, with sign and two decimal points, always in °C.

MDR
GLP

Requests the instrument model name and firmware code.

Requests the calibration data record.

The answer string contains:

- GLP status (1 char): represents a 4 bit hexadecimal encoding.
 - 0x04 - EC calibration available
 - 0x08 - NaCl calibration available
- EC calibration data (if available), which contains:
 - the number of calibrated standards (1 char)
 - the offset factor, with sign and decimal point (7 chars)
 - the cell constant, with sign and decimal point (7 chars)
 - the calibration time, **yymmddhhmmss** (12 chars)
 - standards information (for each standard)
 - standard value, with sign and decimal point (7 chars).
 - standard unit (2 chars; 00- μ S; 01-mS)
 - Reference Temperature with sign and decimal point (5 chars)
 - Temperature Compensation mode (2 chars)
 - 00 - no temperature compensation
 - 01 - automatic temperature compensation
 - 00 - manual temperature compensation
 - TC coefficient with sign and decimal point (5 chars)
 - Na Cl Calibration data
 - the number of calibrated data (1 char)
 - salinity coefficient, with sign and decimal point (7 chars)
 - Cell constant, with sign and decimal point (7 chars)
 - calibration time, **yymmddhhmmss** (12 chars)

- standard information:
- Reference Temperature with and decimal point (5 chars)
- Temperature Compensation mode (2 chars)
 - 00 - no temperature compensation
 - 01 - automatic temperature compensation
 - 00 - manual temperature compensation
- TC coefficient with sign and decimal point (5 chars)

PAR Requests the setup parameters setting.

The answer string contains:

- Instrument ID (4 char)
- SETUP information (2 chars): 8 bit hexadecimal encoding.
 - 0x01 - beep ON (else OFF)
 - 0x04 - degrees Celsius (else degrees Fahrenheit)
- cell constant, with sign and decimal point (6 chars)
- TDS factor, with sign and decimal point (5 chars)
- TC coef, with sign and decimal point (5 chars)
- Reference Temperature, with sign and decimal point (5 chars)
- Temperature Compensation mode (1 char)

NSLx Requests the number of logged samples.

- x =
- E - request for EC range
 - N - request for NaCl range
 - T - request for TDS range

LODExxx: Request the xxxth EC record logged data.

LODNxxx: Request the xxxth NaCl record logged data.

LODTxxx: Request the xxxth TDS record logged data.

LODEALLxx: Request all EC Log on demand. See Note.

LODNALLxx: Request all NaCl Log on demand. See Note.

LODTALLxx: Request all TDS Log on demand. See Note.

Note: The data is sent in frames of 8 records each. "xx" represents the number of the frame. The first frame is labeled 01.

- Errors:**
- “Err3” log on demand empty.
 - “Err4” requested set parameter is not available.
 - “Err5” command argument is wrong.
 - “Err6” requested range not available.
 - “Err7” meter in log mode.
 - “Err8” is sent if instrument is not in measurement mode.
 - “NAK” (21) character is sent when the instrument receives an unknown or a corrupted command.

Note: E - request for EC range.
T - request for TDS range.
N - request for NaCl range.

PROBE MAINTENANCE

EC Probe Maintenance

Rinse the probe with clean water after measurements. If a more thorough cleaning is required, remove the probe sleeve and clean the probe with a cloth or a nonabrasive detergent. Make sure to reinsert the sleeve onto the probe properly and in the right direction. After cleaning the probe, recalibrate the instrument.

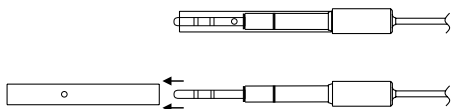

The platinum rings support is made of glass. Take great care while handling the probe.

TROUBLESHOOTING GUIDE

SYMPTOMS	PROBLEM	SOLUTION
Readings fluctuate up and down (noise)	EC probe sleeve not properly inserted; air bubbles inside sleeve	Insert the sleeve. Tap the probe to remove air bubbles
The meter does not accept the standard solution for calibration	Out of order EC probe	Follow the cleaning procedure. If still no results replace the probe
The display shows EC, TDS or NaCl reading blinking	Out of range in EC, TDS or NaCl scale	Recalibrate the meter. Make sure the solution is in specified range. Make sure the LOCK key was not pressed
The meter does not measure the temperature	Broken probe	Replace the probe
The meter fails to calibrate or gives faulty readings	Broken probe	Replace the probe
The meter fails to calibrate NaCl	Incorrect EC calibration	Recalibrate the meter in EC range. Set cell constant to 1
At startup the meter displays all LCD tags permanently	One of the keys is blocked	Check the keyboard or contact the vendor
"Err xx" erro message displayed	Internal error	Power off the meter and then power it on. If the error persists, contact the vendor
CAL "Prod" message at startup	Instrument not factory calibrated	Contact Hanna Instruments Technical Support for factory calibration

ACCESSORIES

CONDUCTIVITY SOLUTIONS

HI70030C	12880 $\mu\text{S}/\text{cm}$ ($\mu\text{mho}/\text{cm}$), 20 mL sachets (25 pcs.)
HI70031P	1413 $\mu\text{S}/\text{cm}$ ($\mu\text{mho}/\text{cm}$), 20 mL sachets (25 pcs.)
HI70039P	5000 $\mu\text{S}/\text{cm}$ ($\mu\text{mho}/\text{cm}$), 20 mL sachets (25 pcs.)
HI7030M	12880 $\mu\text{S}/\text{cm}$ ($\mu\text{mho}/\text{cm}$), 230 mL bottle
HI7031M	1413 $\mu\text{S}/\text{cm}$ ($\mu\text{mho}/\text{cm}$), 230 mL bottle
HI7033M	84 $\mu\text{S}/\text{cm}$ ($\mu\text{mho}/\text{cm}$), 230 mL bottle
HI7034M	80000 $\mu\text{S}/\text{cm}$ ($\mu\text{mho}/\text{cm}$), 230 mL bottle
HI7035M	111800 $\mu\text{S}/\text{cm}$ ($\mu\text{mho}/\text{cm}$), 230 mL bottle
HI7039M	5000 $\mu\text{S}/\text{cm}$ ($\mu\text{mho}/\text{cm}$), 230 mL bottle
HI7030L	12880 $\mu\text{S}/\text{cm}$ ($\mu\text{mho}/\text{cm}$), 500 mL bottle
HI7031L	1413 $\mu\text{S}/\text{cm}$ ($\mu\text{mho}/\text{cm}$), 500 mL bottle
HI7033L	84 $\mu\text{S}/\text{cm}$ ($\mu\text{mho}/\text{cm}$), 500 mL bottle
HI7034L	80000 $\mu\text{S}/\text{cm}$ ($\mu\text{mho}/\text{cm}$), 500 mL bottle
HI7035L	111800 $\mu\text{S}/\text{cm}$ ($\mu\text{mho}/\text{cm}$), 500 mL bottle
HI7039L	5000 $\mu\text{S}/\text{cm}$ ($\mu\text{mho}/\text{cm}$), 500 mL bottle
HI7037L	100% NaCl sea water standard solution, 500 mL bottle
HI8030L	12880 $\mu\text{S}/\text{cm}$ ($\mu\text{mho}/\text{cm}$), 500 mL FDA approved bottle
HI8031L	1413 $\mu\text{S}/\text{cm}$ ($\mu\text{mho}/\text{cm}$), 500 mL FDA approved bottle
HI8033L	84 $\mu\text{S}/\text{cm}$ ($\mu\text{mho}/\text{cm}$), 500 mL FDA approved bottle
HI8034L	80000 $\mu\text{S}/\text{cm}$ ($\mu\text{mho}/\text{cm}$), 500 mL FDA approved bottle
HI8035L	111800 $\mu\text{S}/\text{cm}$ ($\mu\text{mho}/\text{cm}$), 500 mL FDA approved bottle
HI8039L	5000 $\mu\text{S}/\text{cm}$ ($\mu\text{mho}/\text{cm}$), 500 mL FDA approved bottle

TDS SOLUTIONS	
HI70080C	800 ppm (mg/L), 20 mL (25 pcs.)
HI70080P	800 ppm (mg/L), 20 mL (25 pcs.)
HI70032C	1382 ppm (mg/L), 20 mL (25 pcs.)
HI70032P	1382 ppm (mg/L), 20 mL (25 pcs.)
HI70442C	1500 ppm (mg/L), 20 mL (25 pcs.)
HI70442P	1500 ppm (mg/L), 20 mL (25 pcs.)
HI77200C	1500 ppm (mg/L) & pH 7.01, 20 mL (10 pcs.)
HI77200P	1500 ppm (mg/L) & pH 7.01, 20 mL (10 pcs.)
HI7032M	1382 ppm (mg/L), 230 mL
HI7032L	1382 ppm (mg/L), 500 mL
HI70442M	1500 ppm (mg/L), 230 mL
HI70442L	1500 ppm (mg/L), 500 mL

1500 ppm TDS have an approximate conversion factor of:

$$0.65 \text{ ppm} = 1 \mu\text{S/cm}$$

OTHER ACCESSORIES

HI710005	Voltage adapter from 115 VAC to 12 VDC (USA plug)
HI710006	Voltage adapter from 230 VAC to 12 VDC (European plug)
HI710012	Voltage adapter from 240 VAC to 12 VDC (UK plug)
HI710014	Voltage adapter from 230 VAC to 12 VDC (Australia plug)
ChecktempC	Pocket-size thermometer (range -50.0 to 150.0 °C)
HI76404N	Electrode holder
HI76310	Platinum 4-ring conductivity/TDS probe with temperature sensor and 1 m (3.3') cable

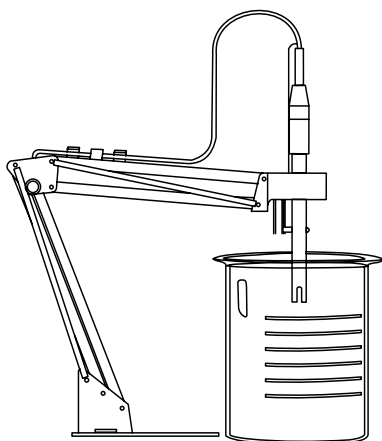

HI92000 Windows[®] compatible software

CERTIFICATION

All Hanna Instruments conform to the **CE European Directives**.

Disposal of Electrical & Electronic Equipment. The product should not be treated as household waste. Instead hand it over to the appropriate collection point for the recycling of electrical and electronic equipment which will conserve natural resources.



Disposal of waste batteries. This product contains batteries, do not dispose of them with other household waste. Hand them over to the appropriate collection point for recycling.



Ensuring proper product and battery disposal prevents potential negative consequences for the environment and human health. For more information, contact your city, your local household waste disposal service, the place of purchase or go to www.hannainst.com.

RECOMMENDATIONS FOR USERS

Before using this product, make sure it is entirely suitable for your specific application and for the environment in which it is used. Any variation introduced by the user to the supplied equipment may degrade the meter's performance. For yours and the meter's safety do not use or store the meter in hazardous environments.

WARRANTY

HI2300 is guaranteed for two years against defects in workmanship and materials when used for their intended purpose and maintained according to instructions. Electrodes and probes are guaranteed for six months. This warranty is limited to repair or replacement free of charge. Damage due to accidents, misuse, tampering or lack of prescribed maintenance is not covered. If service is required, contact your local Hanna Instruments Office. If under warranty, report the model number, date of purchase, serial number and the nature of the problem. If the repair is not covered by the warranty, you will be notified of the charges incurred. If the instrument is to be returned to Hanna Instruments, first obtain a Returned Goods Authorization number from the Technical Service department and then send it with shipping costs prepaid. When shipping any instrument, make sure it is properly packed for complete protection.

Hanna Instruments reserves the right to modify the design, construction or appearance of its products without advance notice.



World Headquarters

Hanna Instruments Inc.

Highland Industrial Park

584 Park East Drive

Woonsocket, RI 02895 USA

www.hannainst.com